

030-00109

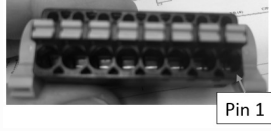

Pin 1

030-00104

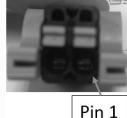

Pin 1

030-00106

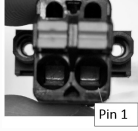

Pin 1

QTY	Ref	Item Number	Description
4'	1	025-00046	WIRE,PVC 18AWG 300V TWSTD,O/P
4'	2	025-00099	WIRE,PVC 18AWG 300V TWSTD
48'	3	025-00057	WIRE,TWSTD,18AWG,O/V BLKJACKET
52'	4	W100134P	CABLE,18/2 R/B GR Y JKT 105C
10	C1	030-00109	Plug, 8PIN, 5.08mm,BLK/ORG
8	C2	030-00104	Plug, 2PIN, 2.08mm,BLK/ORG
2	C4	030-00106	CONN, SOCKET,2PIN,5.08MM BLACK
1	P1	062-00189	PWR/SPLY,24V,96W
1.33	5	800118	WIRE,PVC 18AWG 300VSTR VIOLET
84	-	030-00112	BULK,FERRULE,.75/14MM WHT

Cable specification [length (cable reference)]

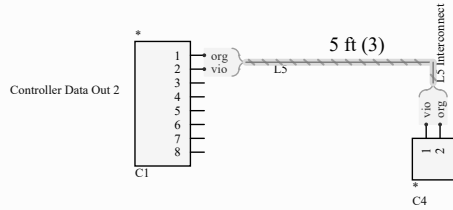
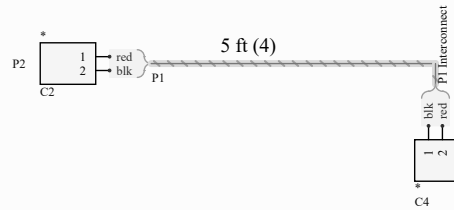
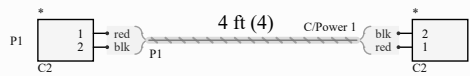

Revision Control
A. Change Labels on Ball, Strike, and Out

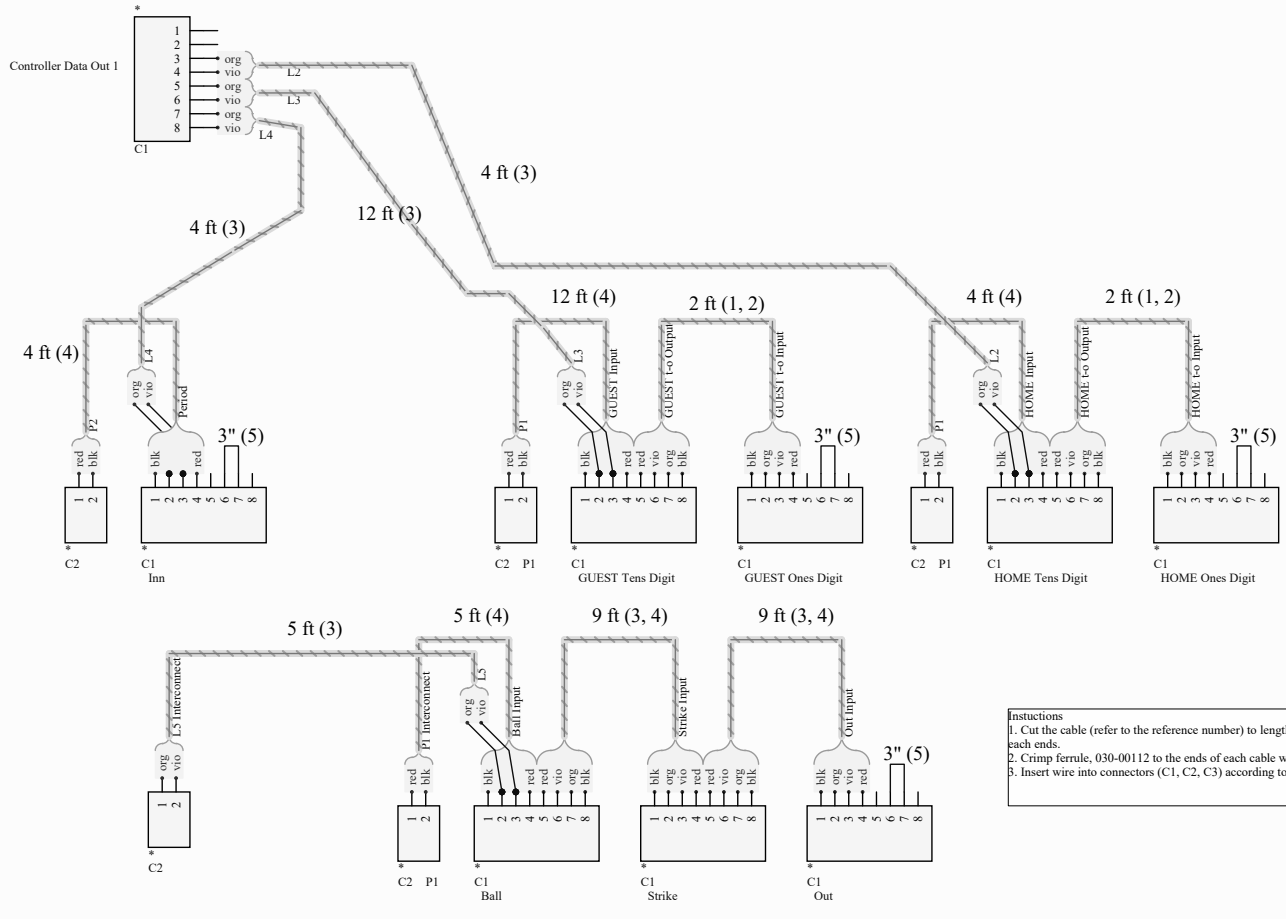

Instructions
1. Cut the cable (refer to the reference number) to length. Label each end.
2. Crimp ferrule, 030-00112 to the ends of each cable wire.
3. Insert wire into connectors (C1, C2, C3) according to pinout.

Title BA9126 Harnesses

