

# ALL AMERICAN SCOREBOARDS™



Everbrite

Site Installation | Model MP-8323LS

Rev. 8/1/11

## SCOREBOARD SITE INSTALLATION INSTRUCTIONS

**CAUTION: All American Scoreboards (AAS) recommends the sign be installed by a licensed contractor, and must meet all local and national building codes.**

**NOTE: AAS RECOMMENDS USING A BOOM/FORKLIFT/CRANE OF SUITABLE SIZE TO USE IN INSTALLATION.**

### Unpacking/Pre-Installation

Dependent on the Model ordered, the All American Scoreboard unit comes crated with different items attached and/or unattached and with different installation hardware.

**! OPERATION OF THE UNIT WITH THE ELECTRICAL CIRCUITRY EXPOSED IS DANGEROUS. BE SURE ALL TOOLS AND ANY OTHER MATERIALS ARE REMOVED FROM THE UNIT, AND ALL ACCESS COVERS ARE REPLACED AND CLOSED BEFORE POWER IS TURNED ON.**

**NOTE:** Take care uncrating as not to damage the units.

The shipment should include:

- Installation instructions (this document).
- Operator's Manual.
- LED Scoreboard Cabinet(s).
- Keypad Console.
- Scoreboard Antenna (Radio System only)
- Junction Box (Hard-wire only)
- Mounting Hardware (see parts list.)

**NOTE: Upon receipt, check for visible damage. If damage is found at the time of delivery, consignee must obtain an 'Inspection of Bad Order' from the delivering carrier.**

If damage is found after shipment has been accepted, visit [www.AllAmericanScoreboards.com](http://www.AllAmericanScoreboards.com) for the damage claim procedure or contact your sales rep.

### - Installation Steps -

**Prior to installation, set I-Beams in required concrete footing. Footing depth varies heavily by soil conditions, climate and environmental factors. Depth of footing must comply with local ordinances. I-Beams must be level.**

**Step 1:** Scoreboards are installed from the bottom up and connected by pins. Measure from the top of the I-Beams to the appropriate length so the top of the scoreboard (or scoreboard + ad panels) will be flush with the top of the I-Beam.

**Step 2:** Screw Threaded Rods (Item 7) into the Spring Nuts (Item 8) and tighten using 1/2" Nut and Lock Washer (Items 9 and 10).

**Step 3:** Lift the lower cabinet and center between the poles. **It is critical that the bottom panels are level to ensure upper panels and entire scoreboard are also level.**

**Step 4:** Install Spring Nuts with Threaded Rods by sliding in from the end or twist them **CLOCKWISE** into the mounting channels on the back of the scoreboard (the spring nuts have a rounded edges for twisting clockwise only), approximate position on each side of the I-beams (See Figure 2).

**Step 5:** After leveling and centering the lower panel, secure to I-beams using the supplied 12" strut (Item 4) and 1/2" Flat Washer, Lock Washer and Hex Nut (Figures 9,10,11), taking care not over tighten and strip or pull the spring nuts out, **50/60 FT/LB torque max** (See Figure 2, Detail A). The lower panel should be secured using (4) 12" strut channels.

**Step 6:** Lower upper cabinet a few inches over the lower cabinet. Remove adhesive from the upper cabinet and carefully route cables through the hole of the upper cabinet and down to the lower cabinet through the cable raceway tube, ensuring to not stress the cables.

**Step 7:** Lower upper panel onto pins and cable raceway tube of the bottom panel. Use the same strut mounting procedure (see Figure 2) as the lower panel. Upper panels are secured by using (2) 12" strut channels.

If no Ad Panels will be installed, skip to Step 9.

**Step 8:** If using an Advertiser Panel, using a 9/16" drill, drill through the I-Beam to install the Mounting Angle (Item 5) on to the outside top of the I-Beam (see Figure 1). Attach a two piece Advertiser Panel using a 3/16" bar on top with 4-3/8" bolts, nuts and washers and the sides with 2-3/8" bolts, nuts and washers.

**Step 9:** Remove the face exposing the controller assembly of the scoreboard unit by unscrewing the PH screws, top and sides, lift and remove the face and set aside for reinstallation. Connect cables from the upper cabinet to the Controller Plate Assembly according to the connector labels on the harness, (see Back Page), be sure to use a drip loop and keep a 1/2" space from the bottom of the unit. Connectors will be labeled appropriately. There will be an adhesive sheet mounted inside the scoreboard or inside controller assembly cover with additional detailed information.



**Step 10: HARD-WIRE ONLY.** Install the Junction Box at chosen location (i.e. press box or dug-out) and hook-up Power/Data Cable to terminal block (see Figure 3 Detail-D).

**Step 11:** Attach the grounding wire to ground.

**Step 12:** Install the cable conduit and the power cut of switch box (recommended) onto the beam and run the power through the conduit to the sign.

**Step 13: HARD-WIRE ONLY.** Install the cable conduit onto the beam and run the data cable from the junction box through the conduit to the data box on the back of the scoreboard. Attach the data cable - Pin 5 on console (and scorer's booth junction box) will connect to the Blue and White wire, Pin 4 will connect to the Blue Wire.

**Step 14: RADIO ONLY.** Remove the RED button cover from the antenna mount located on the face of the board and screw on the extra antenna.

**Step 15:** Attach the Board power line to the terminal block in the power supply assembly; Black to Line, White to Neutral, Green to Ground. Reinstall cover.

**Step 16:** Reinstall board face into cabinet frame.

**Step 17:** Power up scoreboard and run set-up as described in Operator's Manual.

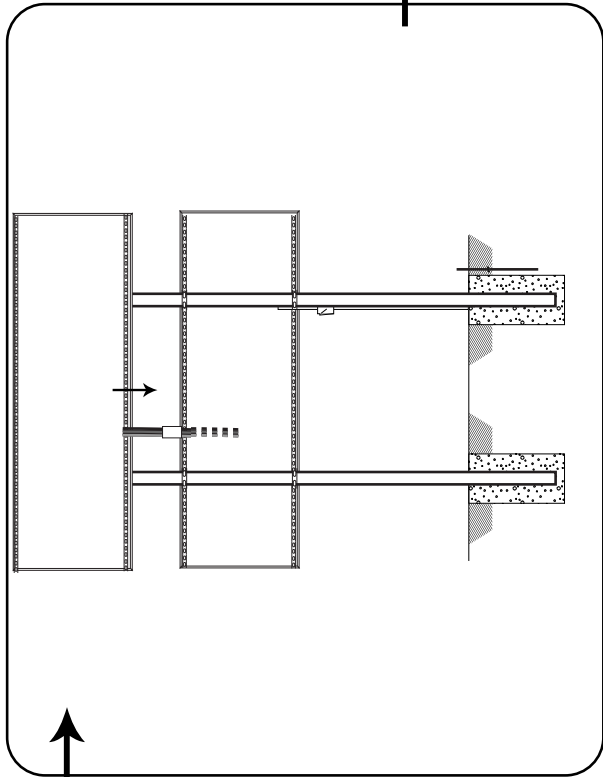
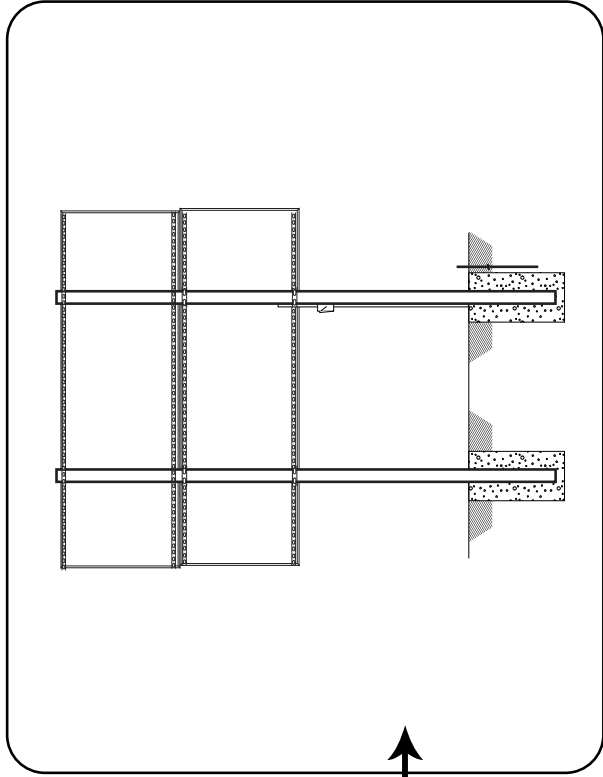
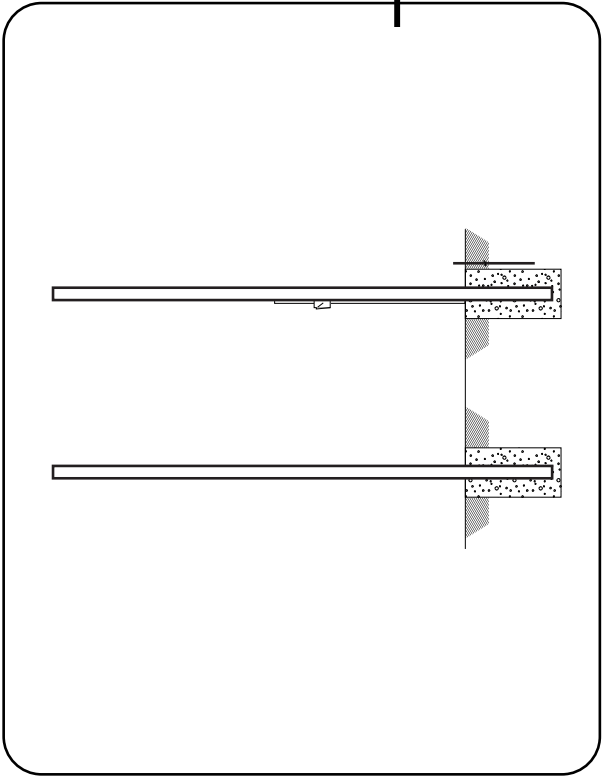
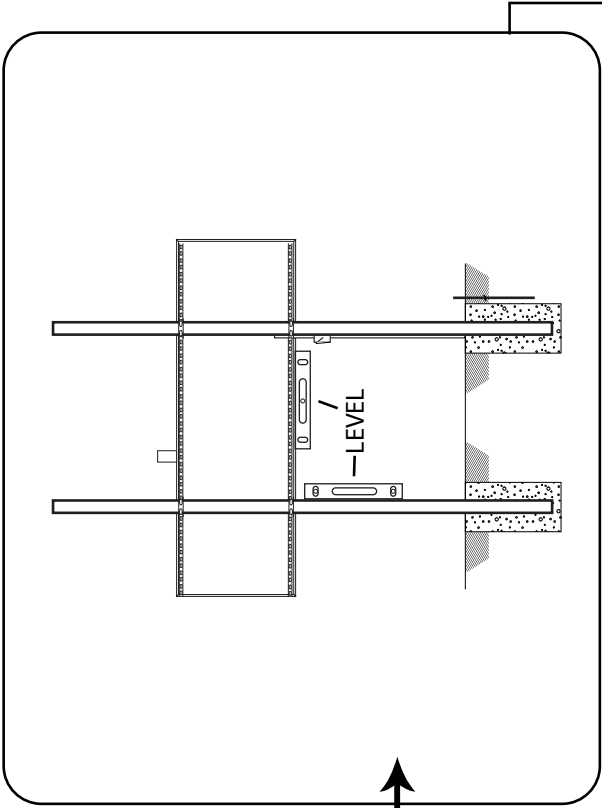

Typical 2 Cabinet Scoreboard Installation Illustration

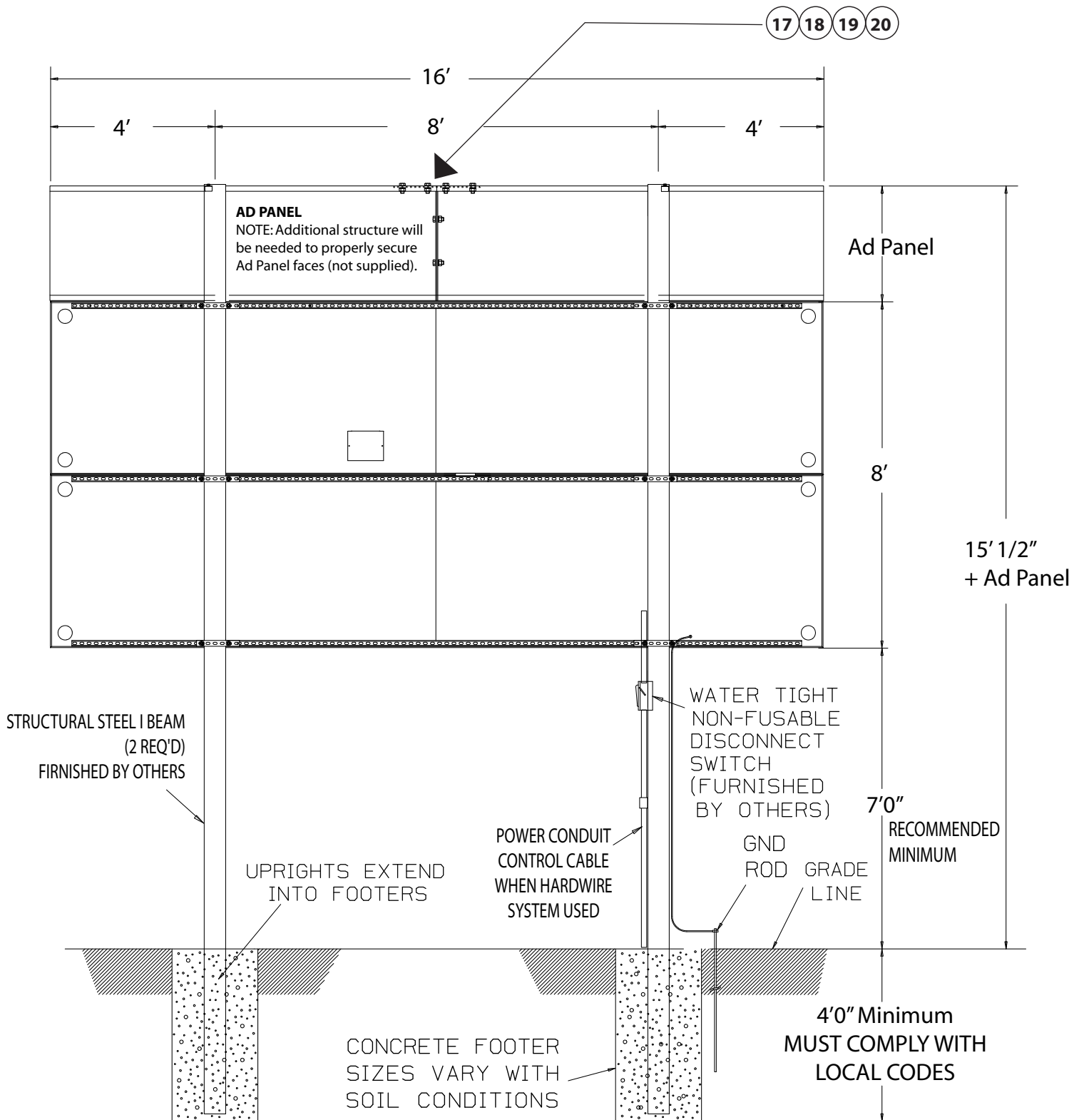

**NOTE: Foundation shown for illustration only. Actual foundation needs to meet national and local building codes. Sites must be surveyed by qualified engineer. All measurements are for reference only.**

Figure 2: Mounting and Ad Panel Detail.

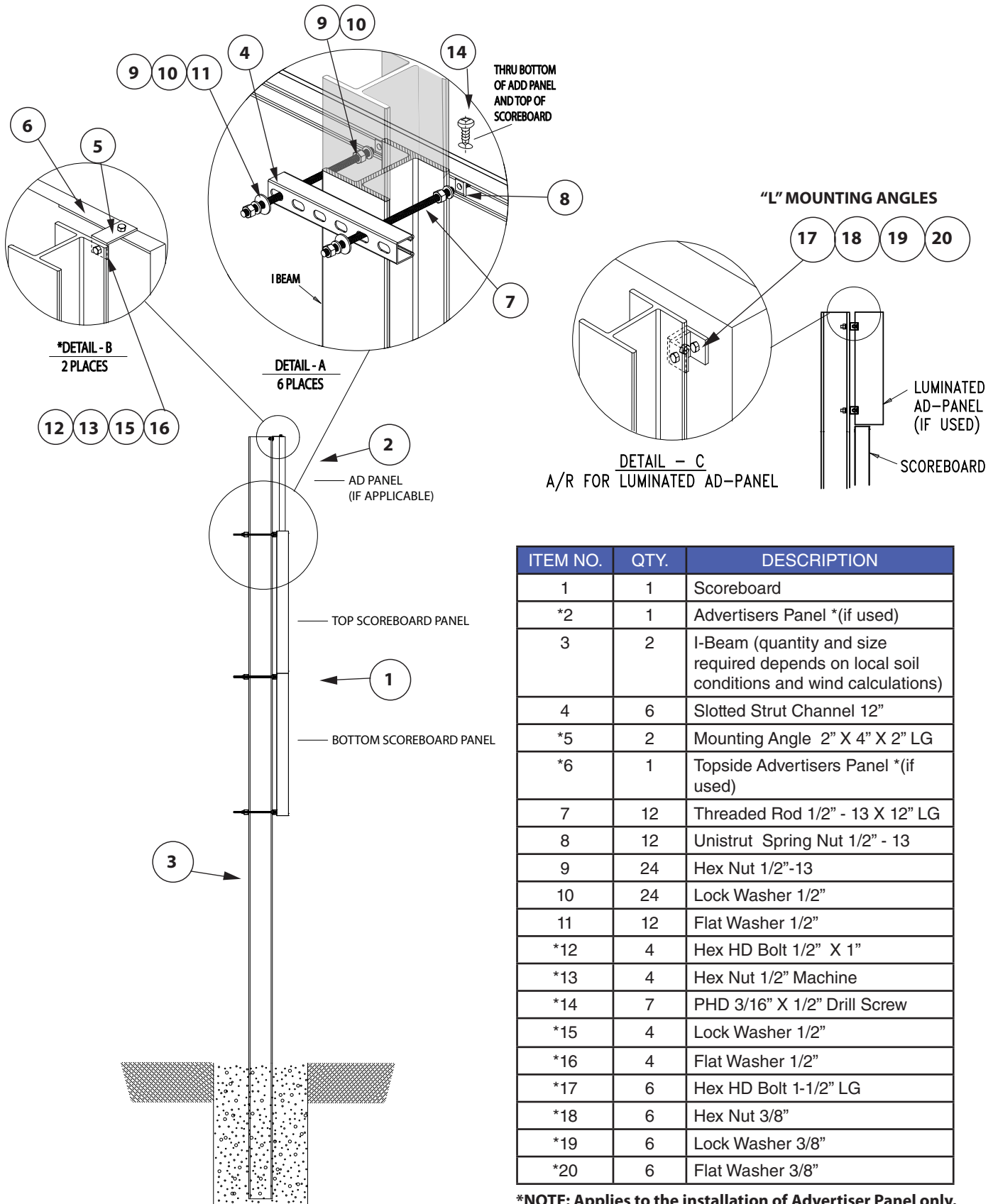

ITEM NO.	QTY.	DESCRIPTION
1	1	Scoreboard
*2	1	Advertisers Panel *(if used)
3	2	I-Beam (quantity and size required depends on local soil conditions and wind calculations)
4	6	Slotted Strut Channel 12"
*5	2	Mounting Angle 2" X 4" X 2" LG
*6	1	Topside Advertisers Panel *(if used)
7	12	Threaded Rod 1/2" - 13 X 12" LG
8	12	Unistrut Spring Nut 1/2" - 13
9	24	Hex Nut 1/2"-13
10	24	Lock Washer 1/2"
11	12	Flat Washer 1/2"
*12	4	Hex HD Bolt 1/2" X 1"
*13	4	Hex Nut 1/2" Machine
*14	7	PHD 3/16" X 1/2" Drill Screw
*15	4	Lock Washer 1/2"
*16	4	Flat Washer 1/2"
*17	6	Hex HD Bolt 1-1/2" LG
*18	6	Hex Nut 3/8"
*19	6	Lock Washer 3/8"
*20	6	Flat Washer 3/8"

\*NOTE: Applies to the installation of Advertiser Panel only.

NOTE: Foundation shown for illustration only. Actual foundation needs to meet national and local building codes.

# Hardwire Scoreboard Wiring With a Standard Junction Box

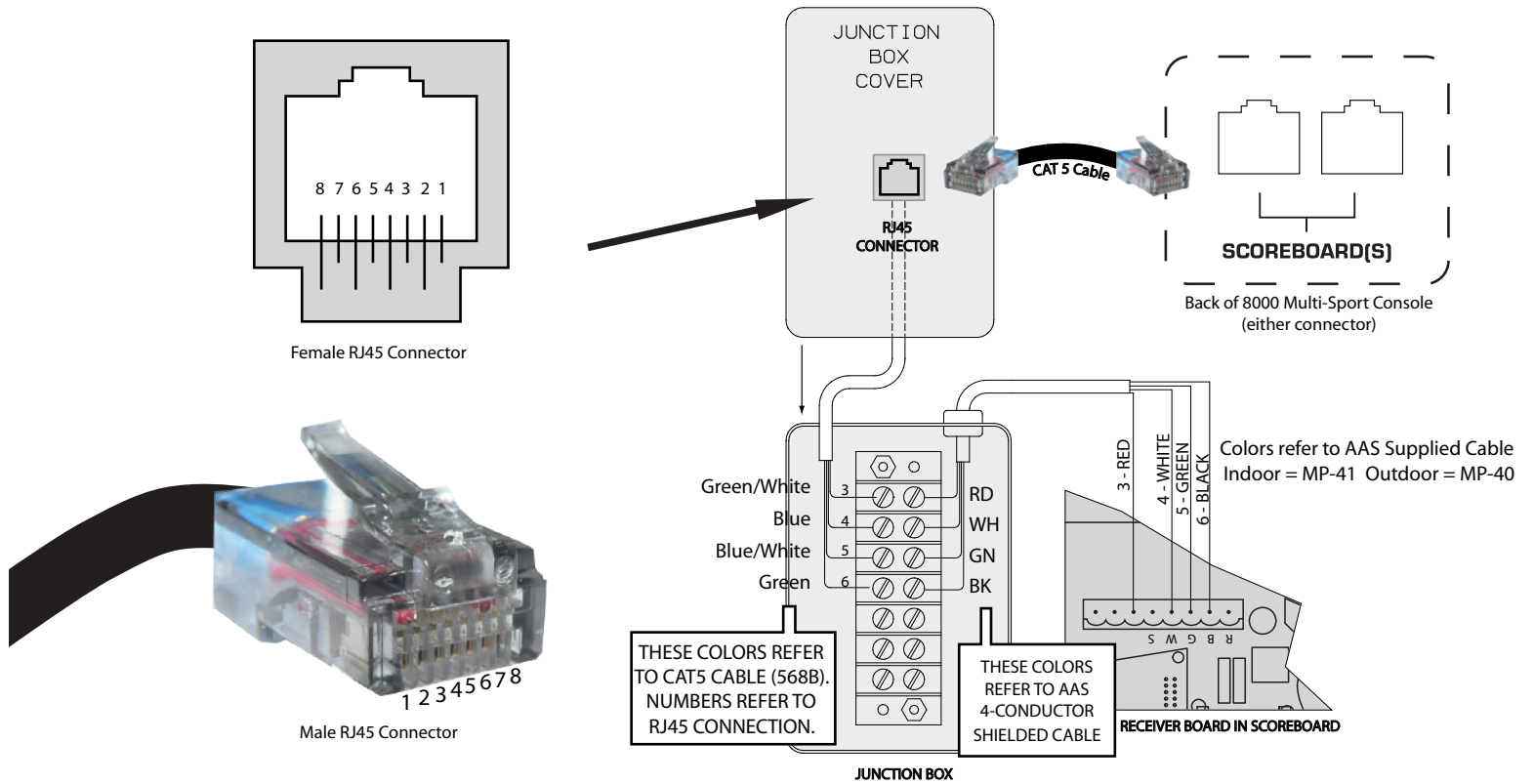

# Wiring a Supplemental Display With a Single Junction Box

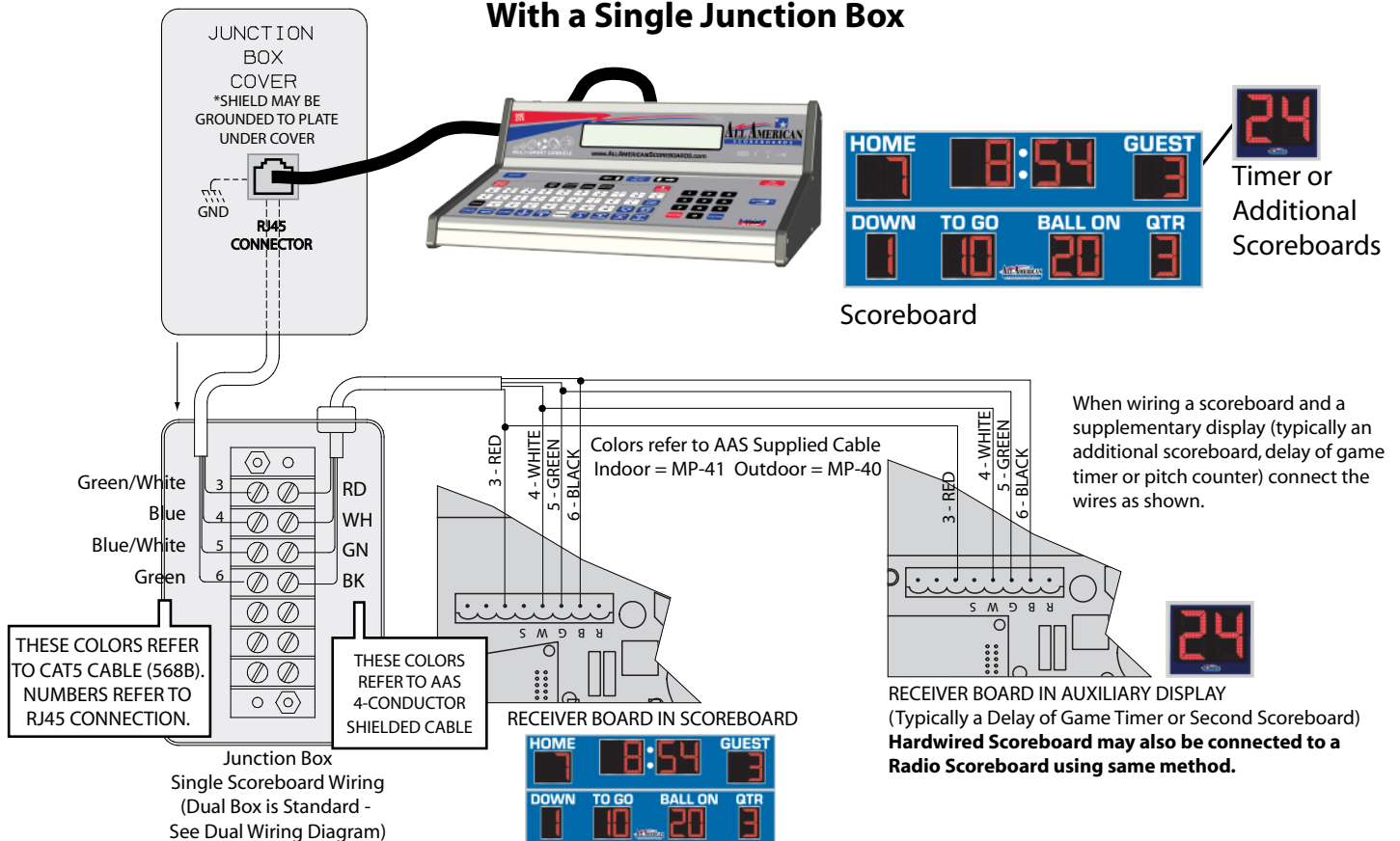

# Hard Wire Setup / Hardwire Override Capable

## Using a Dual Capable Junction Box

All radio scoreboards have the ability to be used as a hardwire. When installed properly, the radio on the scoreboard will turn off when a console is plugged into the hardwire input. **Unless proper wiring (Leads 3 & 6) is run to the RJ45 Terminal Box and Junction Box, the radio will need to be removed from the scoreboard to connect via hard wire. To avoid this situation, two additional wires are required to allow the hardwire data to override the radio signal (Leads 3 & 6).**

The 8000 Series Console can plug directly into the scoreboard via a standard CAT5 cable and RJ45 connections. All American Scoreboards recommends using a junction box (either a standard single or a dual capable). Type of junction box and cable lengths will be determined at point of sale.

**Outdoor boards will require a water tight junction box. Data connections will be directly connected to the receiver board in scoreboard. Data connection and AC power cannot run in same conduit.**

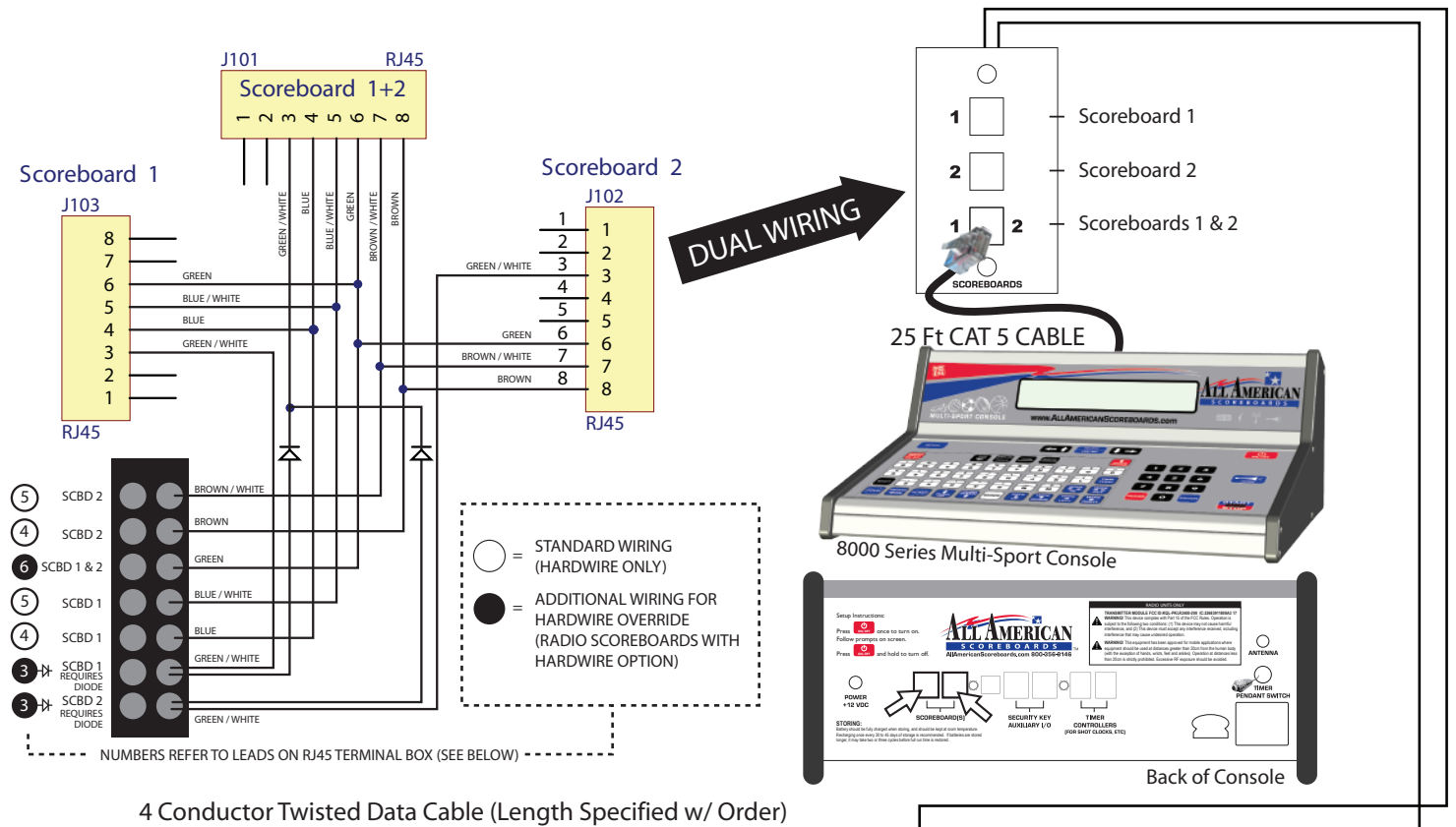

4 Conductor Twisted Data Cable (Length Specified w/ Order)

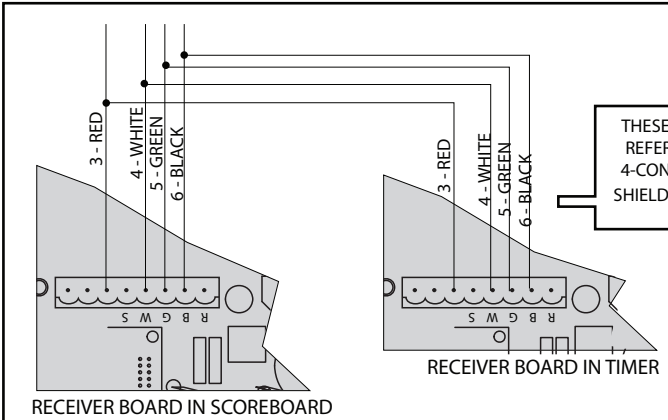

THESE COLORS REFER TO AAS 4-CONDUCTOR SHIELDED CABLE

4 Conductor Twisted Data Cable (Length Specified w/ Order)

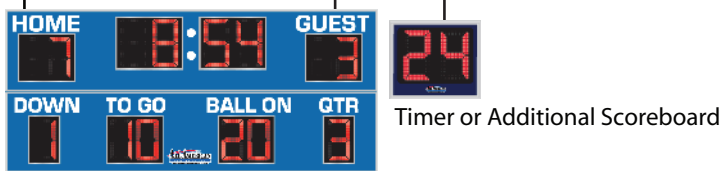
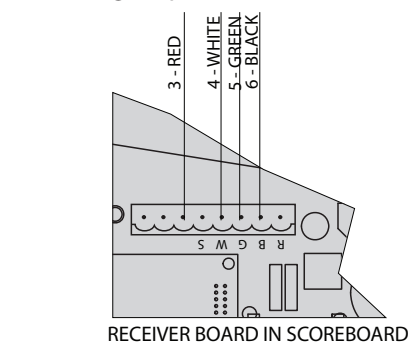

Scoreboard 1

\*Actual scoreboard configurations may differ.



Scoreboard 2 or Auxiliary Board (Scoreboard, Timer, Pitch Count, etc.)



# 8325LS Baseball Controller Plate

Scoreboard Type: 500

Power Supply Outputs:

POWER 1 (Quad):

P1.1 ≈ 0.74A P1.2 ≈ 3.90A

P1.3 ≈ 2.90A P1.4 ≈ 2.90A

POWER 2 (Quad):

P2.1 ≈ 3.87A P2.2 ≈ 3.87A

P2.3 ≈ 3.87A P2.4 ≈ 3.87A

"C" refers to controller board output. If Indicators are used, C4 data will go to the Indicator Driver Board and then to the digit(s).

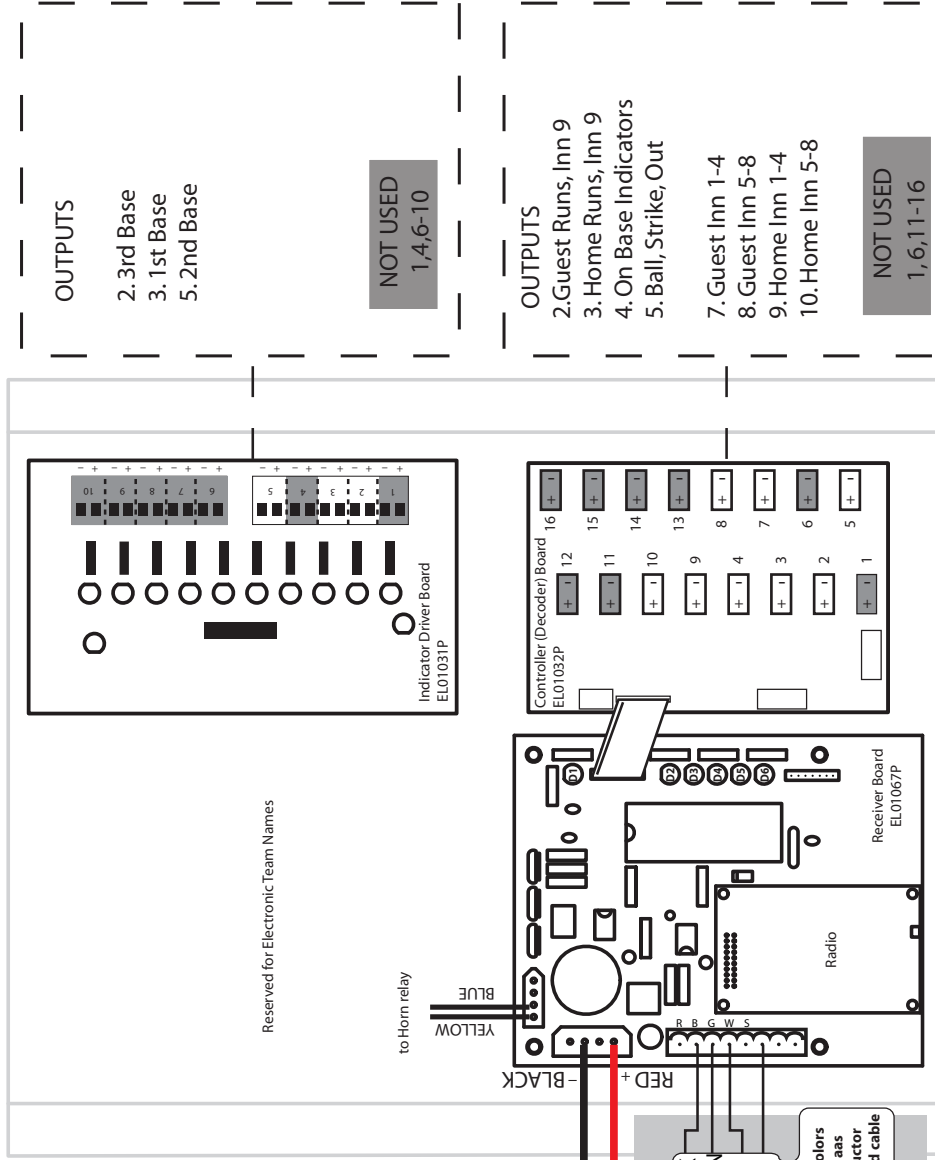

OUTPUTS

- 2. 3rd Base
- 3. 1st Base
- 5. 2nd Base

NOT USED  
1,4,6-10

OUTPUTS

- 2. Guest Runs, Inn 9
- 3. Home Runs, Inn 9
- 4. On Base Indicators
- 5. Ball, Strike, Out
- 7. Guest Inn 1-4
- 8. Guest Inn 5-8
- 9. Home Inn 1-4
- 10. Home Inn 5-8

NOT USED  
1,6,11-16

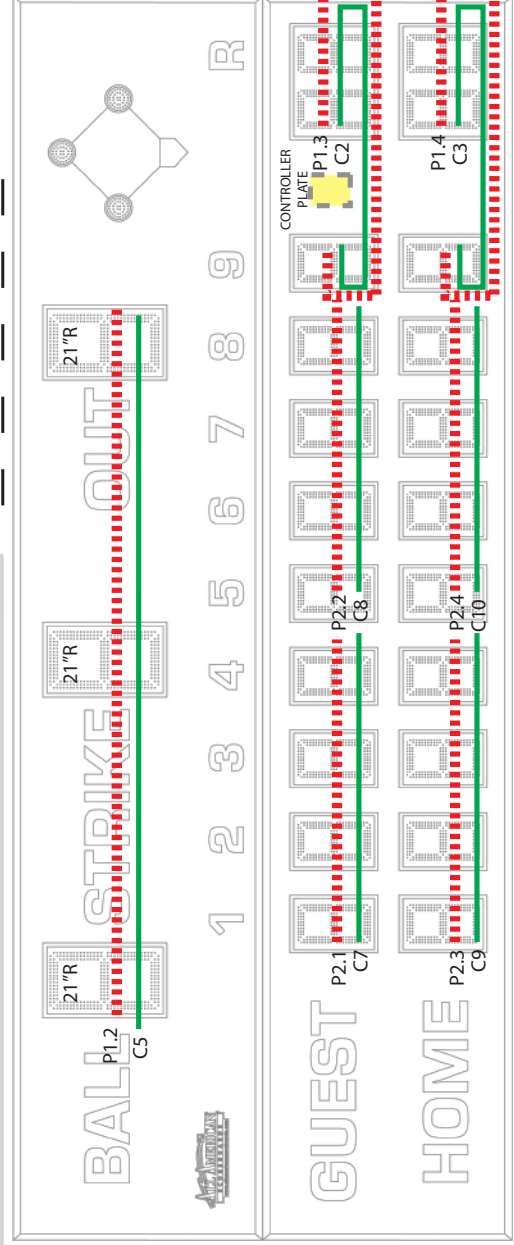

All Digits in lower panels are 14" Red. — = DATA - - - - - = 10.5VDC POWER

115VAC/60Hz - 6.0 Amps